

System: Laufschiene eingetütet, keine Nut im Boden, ohne Blende, mit Laufwerk für verdeckte Montage, für 1-2 Glasuren bis 35 kg.

Design Alu-Glasfixierungsprofil 24/12 mm - Inslide

System: Top track groove mounted, no groove in the floor, without panel, with running gear for concealed fixing, for 1-2 glass doors up to 35 kg.

Design aluminium glass fixing profile 24/12 mm - Inslide

Système: Rail de roulement dans rainuré, aucune rainure dans le sol, sans cache, avec chariot de roulement pour montage caché, pour 1-2 portes en verre de 35 kg max.

Design profile de fixation du verre en alu 24/12 mm - Inslide

Klebstoff-Empfehlungen für Glas:

Recommended adhesive for glass:

Colle recommandée pour verre:

- ELCH PRO 3B Silikon 71
- 3M Scotch Weld DP 105

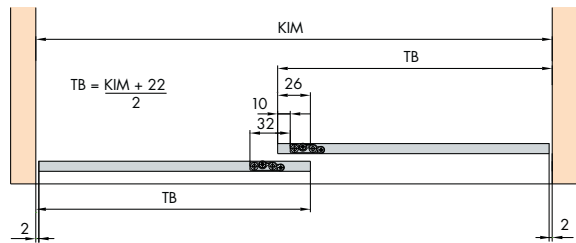
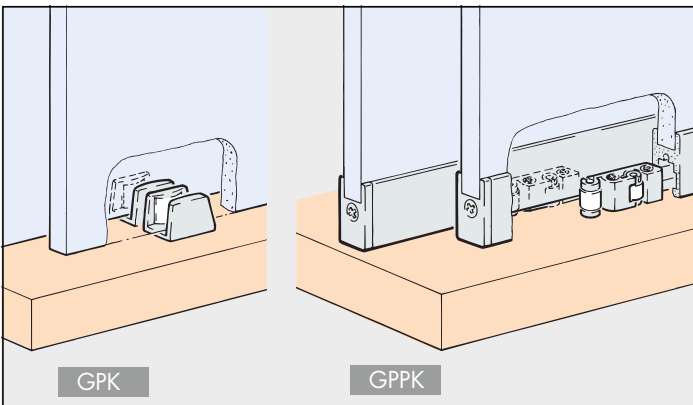

Einbaubeispiele / Mounting examples / Esempi di montaggio

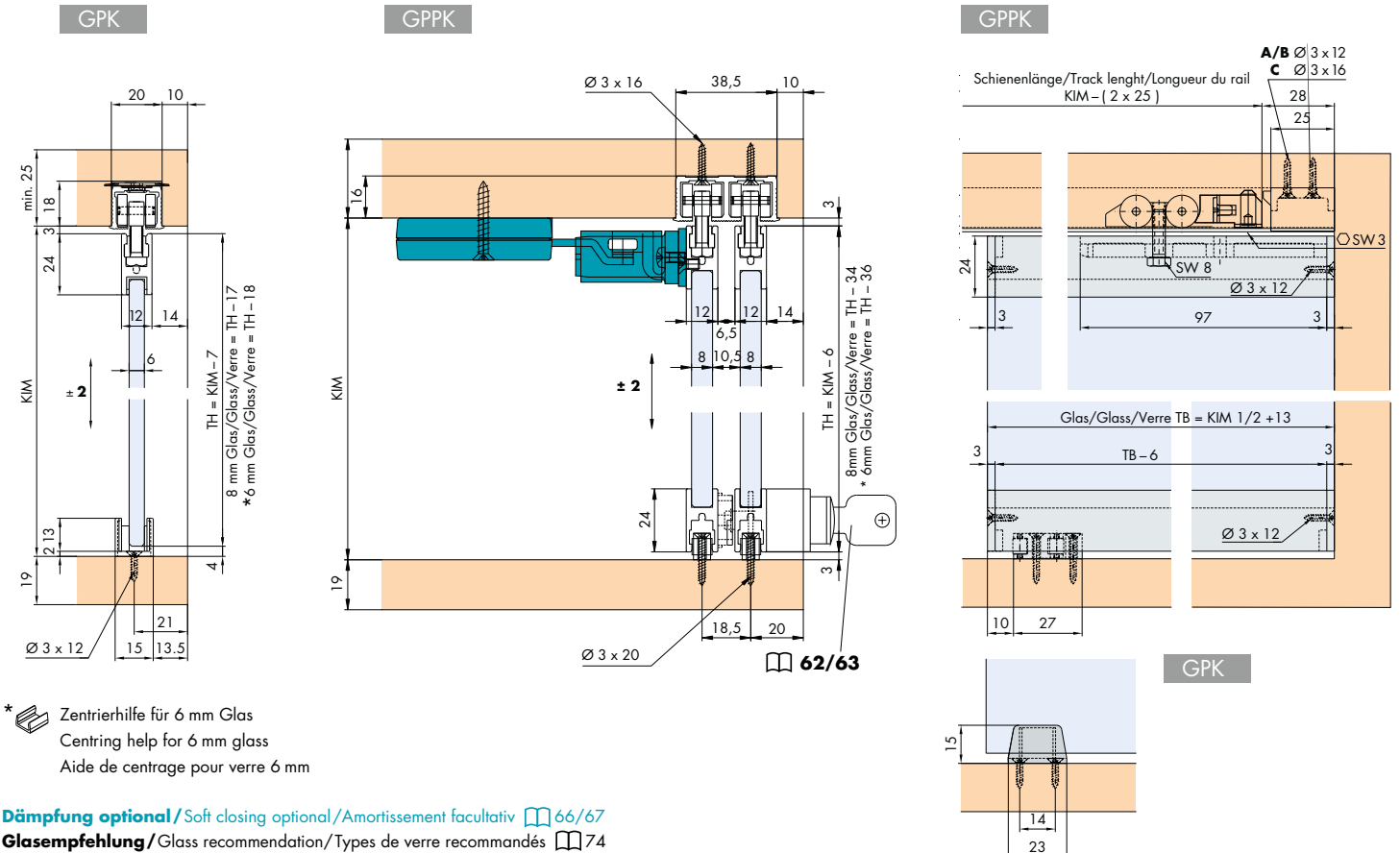

* Zentrierhilfe für 6 mm Glas
Centring help for 6 mm glass
Aide de centrage pour verre 6 mm

Dämpfung optional / Soft closing optional / Amortissement facultatif 66/67
Glasempfehlung / Glass recommendation / Types de verre recommandés 74

Befestigungsvarianten

Mounting options
Variantes de fixation

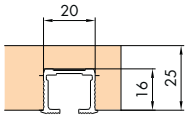

A zum Verstemmen oder Kleben
for press-fitting or glueing
à enfoncer ou coller

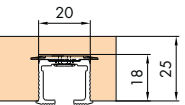

B mit Drehriegel (nicht für Hartholz/MDF)
with swivel lug
(not for hard wood/MDF)
avec verrou
(pas pour bois dur/MDF)

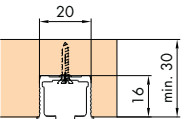

C zum Schrauben
screwed on
à visser

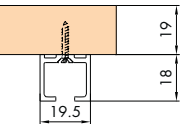

D zum Aufschauben
surface mounted
à visser en applique

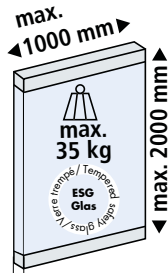

max. 35 kg
max. 12 mm
6-8 mm Glas
Glass/Verre

Türgewichte
Panel weights
Poids de portes **75**

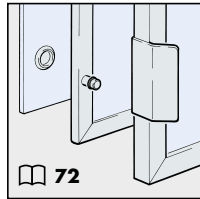

Garnituren / Sets / Garnitures

GPK		No. 053.3100.080	
1 Türe Door Porte			2x
			2x
			1x
			1x
			2x

GPPK		No. 053.3100.081	
1 Türe Door Porte			2x
			2x
			4x
			3x
			1x

Zubehör / Accessories / Accessoires

A Einfachlaufschiene Alu, zum Verstemmen oder Kleben

Single top track aluminium, for press-fitting or glueing
Rail de roulement simple en alu, à enfoncer ou coller

Gr./Size

Art. No.

2500 mm 053.3116.250
3500 mm 053.3116.350
6000 mm 053.3116.600

B Einfachlaufschiene Alu, mit Drehriegel (nicht für Hartholz/MDF)

Single top track aluminium, with swivel lug (not for hard wood/MDF)
Rail de roulement simple en alu, avec verrou (pas pour bois dur/MDF)

2500 mm 053.3118.250
3500 mm 053.3118.350
6000 mm 053.3118.600

C Einfachlaufschiene Alu, gelocht, zum Schrauben

Single top track aluminium, pre-drilled, screwed on
Rail de roulement simple en alu, perforé, à visser

2500 mm 053.3117.250
3500 mm 053.3117.350
6000 mm 053.3117.600

C Doppellaufschiene Alu, gelocht, zum Schrauben

Dual top track aluminium, pre-drilled, screwed on
Rail de roulement double en alu, perforé, à visser

2500 mm 053.3120.250
3500 mm 053.3120.350
6000 mm 053.3120.600

D Einfachlaufschiene Alu eloxiert, gelocht, zum Aufschauben

Single top track aluminium anodized, pre-drilled, surface mounted
Rail de roulement simple en alu anodisé, perforé, à visser en applique

2500 mm 053.3069.250
3500 mm 053.3069.350
6000 mm 053.3069.600

Glasfixierungsprofil Alu, eloxiert

Glass fixing profile aluminium, anodized
Profilé de fixation du verre en alu, anodisé

2500 mm 053.3072.250
3500 mm 053.3072.350
6000 mm 053.3072.600

Schienenendstück zu Einfachlaufschiene eingenetzt, Kunststoff grau

Track-end piece for single top track groove mounted, plastic grey
Pièce d'extrémité pour rail de roulement simple, rainuré, plastique gris

2 x 053.3062.003
 100 x 053.3062.002

Schienenendstück zu Doppellaufschiene, eingenetzt, Kunststoff grau

Track-end piece for dual top track groove mounted, plastic grey
Pièce d'extrémité pour rail de roulement double, rainuré, plastique gris

2 x 053.3078.003
 50 x 053.3078.002

