

System: Laufschiene mit Festglashalterung, Wand- oder Deckenmontage, Glasklemmschuh mit Laufwerk für verdeckte Montage, für 1 Glasure bis 35 kg.

System: Top running track, with fixed glass support profile, wall- or ceiling mounted, clamping shoe with running gear for concealed fixing, for 1 glass panel up to 35 kg.

Système: Rail de roulement en haut, avec porte-vitre fixe, montage mural ou au plafond, mâchoire de serrage avec chariot de roulement pour montage caché, pour 1 porte en verre jusqu'à 35 kg.

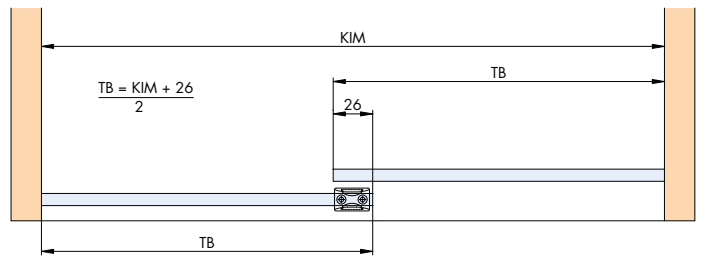
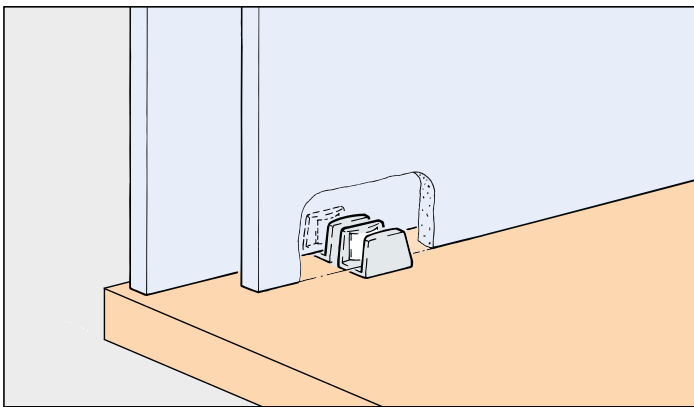

Einbaubeispiele / Mounting examples / Exemples de montage

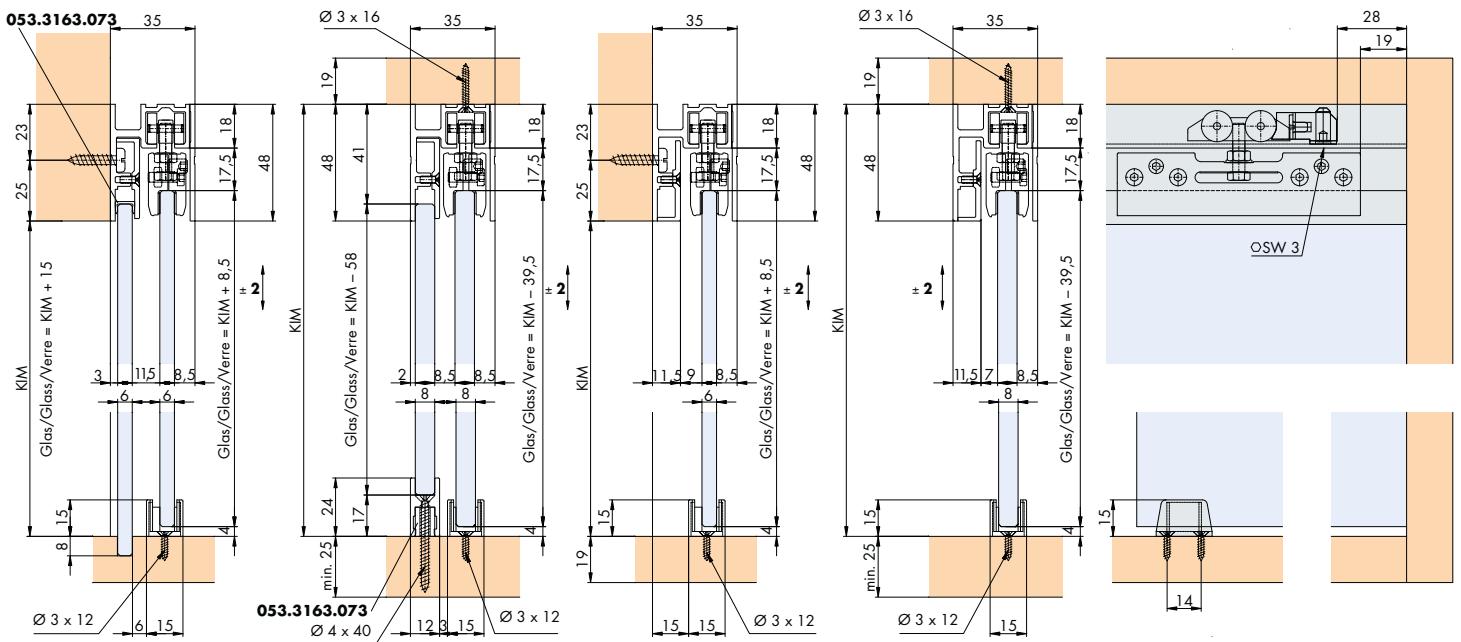

Einbau des Glasfixierungsprofils (Festglas)

Installation of the glass fixing profile (fixed glass)
Installation du profil de fixation du verre (vitre fixe)

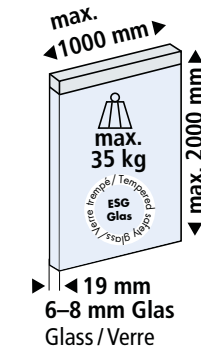
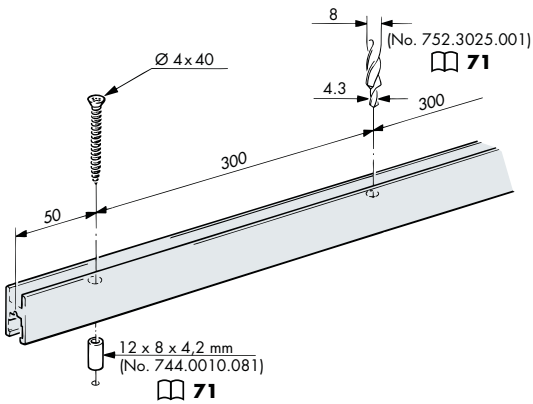

Türgewichte
Door weights
Poids de portes **75**

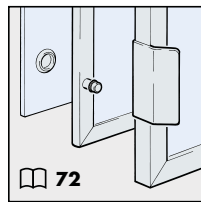

Garnituren / Sets / Garnitures

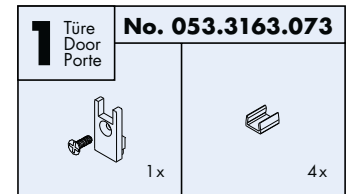
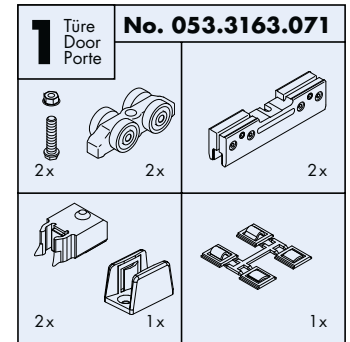

Zubehör / Accessories / Accessoires

Einfachlaufschiene Alu eloxiert, gelocht, zum Aufschrauben, mit integrierter Blende

Single top track aluminium anodized, pre-drilled, surface mounted, with integrated panel
Rail de roulement simple en alu anodisé, perforé, à visser en applique, à cache intégré

Gr./Size	Art. No.
2500 mm	053.3070.250
3500 mm	053.3070.350
6000 mm	053.3070.600

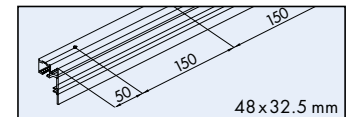

Festglashalteprofil Alu eloxiert, gelocht

Fixed glass support profile aluminium anodized, pre-drilled
Profil de retenue de porte-vitre fixe en alu anodisé, perforé

2500 mm	053.3071.250
3500 mm	053.3071.350

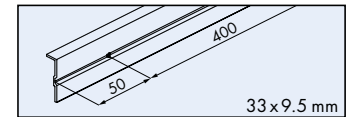

Blende Alu, eloxiert**

Panel aluminium, anodized**
Cache alu, anodisé**

2500 mm	053.3075.250
3500 mm	053.3075.350

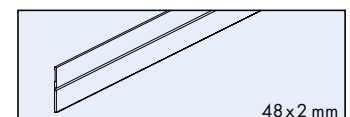

Glasfixierungsprofil Alu, eloxiert

Glass fixing profile aluminium, anodized
Profilé de fixation du verre en alu, anodisé

2500 mm	053.3072.250
3500 mm	053.3072.350
6000 mm	053.3072.600



Taptite Schrauben M3 x 8, zu Festglashalteprofil

Taptite screws, M3 x 8, for fixed glass support profile
Vis Taptite M3 x 8, pour profil de retenue de porte-vitre fixe

50 x	098.0007.101
------	--------------

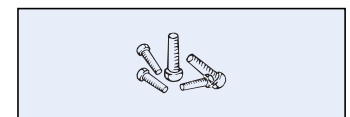

Stufenbohrer für CLIPO 35 Festglas

Stepped drill bit for CLIPO 35 fixed glass
Foret à étage pour CLIPO 35 vitre fixe

1 x	752.3025.001
-----	--------------

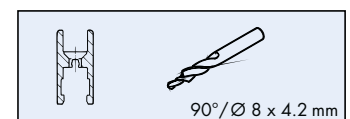

Distanzbuchse Kunststoff für CLIPO 35 Festglas

Spacer bush plastic for CLIPO 35 fixed glass
Douille d'écartement en plastique pour CLIPO 35 vitre fixe

10 x	744.0010.081
------	--------------

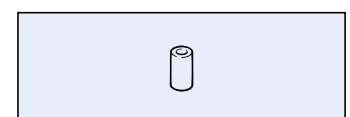

** **Doppelklebeband verwenden / use double-sided adhesive tape / utiliser un ruban adhésif à double face**
z.B./e.g./p. ex. 3M Scotchtype 4664/4905-f/4936/4930