

**System: Laufschiene eingetütet, Glasklemmschuh mit Laufwerk und Blende, für 1-2 Glastüren bis 35 kg. Design Alu-Blende Klemmschuh**

System: Top running track, clamping shoe with running gear and panel, for 1-2 glass panels up to 35 kg.  
Design aluminium panel for clamping shoe

Système: Rail de roulement en haut, mâchoire de serrage avec chariot de roulement et cache, pour 1-2 portes en verre jusqu'à 35 kg.  
Design cache en alu pour mâchoire de serrage

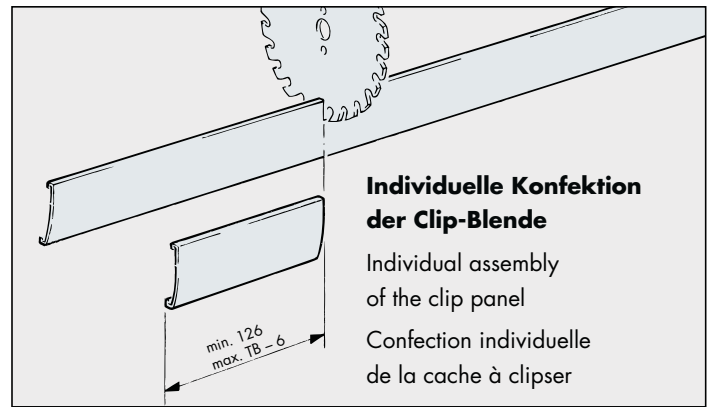
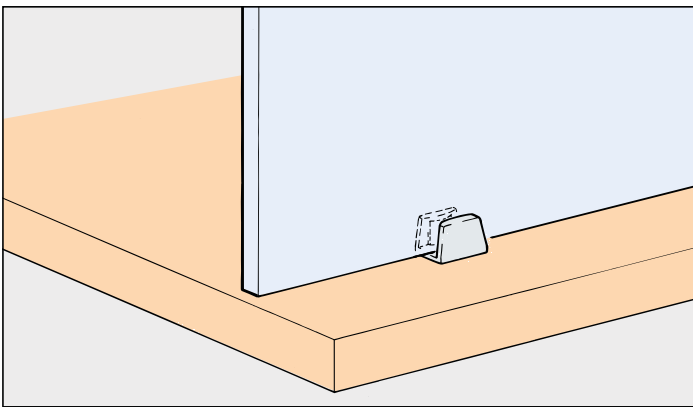

**Einbaubeispiele / Mounting examples / Exemples de montage**

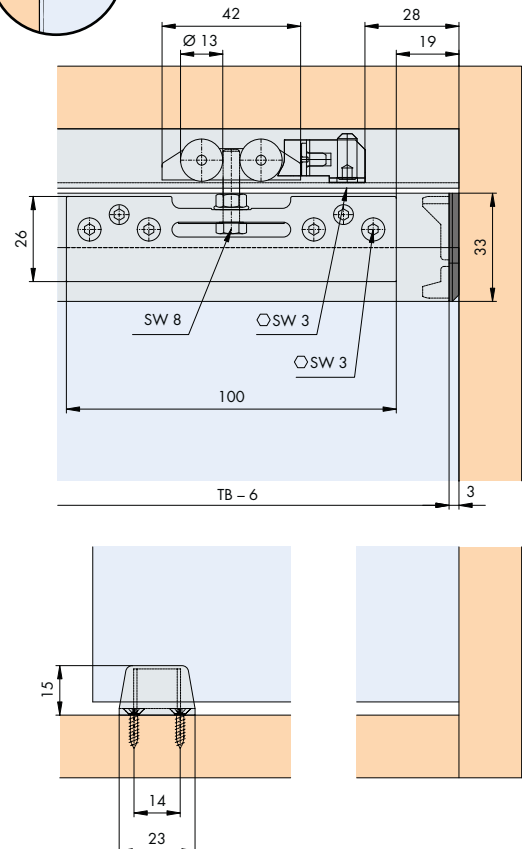
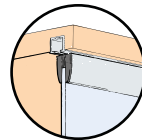
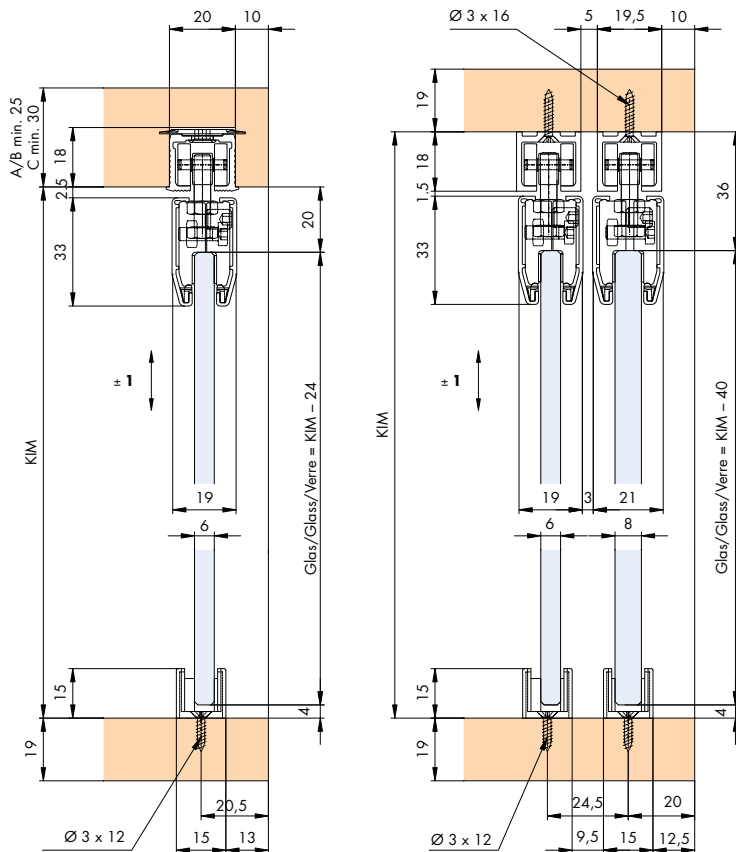

**Einbaubeispiele mit Glasbearbeitung**

Mounting examples with machining of the glass

Exemples de montage avec usinage du verre

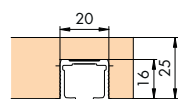
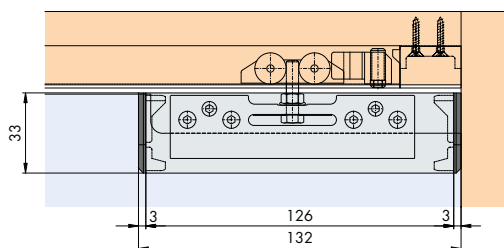
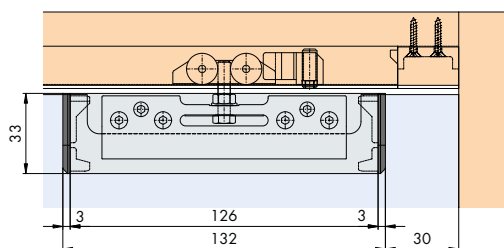

**A zum Verstemmen oder Kleben**  
calked fitting or glueing  
à enfoncer ou coller

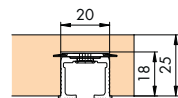

**B mit Drehriegel (nicht für Hartholz/MDF)**  
with swivel lug (not for hard wood/MDF)  
avec verrou (pas pour bois dur/MDF)

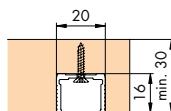

**C zum Schrauben**  
screwed on  
à visser

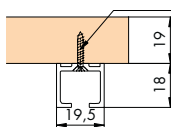

**D zum Aufschauben**  
surface mounted  
à visser en applique

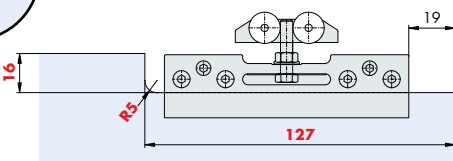
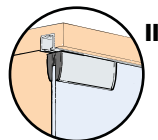
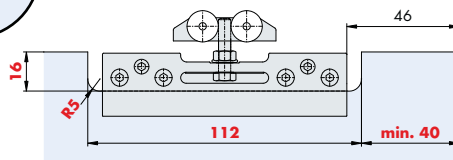
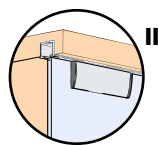

**Garnituren / Sets / Garnitures**

**1** Türe Door Porte **No. 053.3163.071**

**1** Türe Door Porte **No. 053.3163.072**

1 x bestellen/order/commander  
II/III  
2 x bestellen/order/commander

max. 1000 mm  
max. 2000 mm

**72**

**Türgewichte**  
Door weights  
Poids de portes **75**

19 mm  
6-8 mm Glas  
Glass/Verre

**Zubehör / Accessories / Accessoires**

	Gr./Size	Art. No.
<b>A Einfachlaufschiene Alu, zum Verstemmen oder Kleben</b> Single top track aluminium, for press-fitting or glueing Rail de roulement simple en alu, à enfoncer ou coller	2500 mm 3500 mm 6000 mm	053.3116.250 053.3116.350 053.3116.600
<b>B Einfachlaufschiene Alu, mit Drehriegel (nicht für Hartholz/MDF)</b> Single top track aluminium, with swivel lug (not for hard wood/MDF) Rail de roulement simple en alu, avec verrou (pas pour bois dur/MDF)	2500 mm 3500 mm 6000 mm	053.3118.250 053.3118.350 053.3118.600
<b>C Einfachlaufschiene Alu, gelocht, zum Schrauben</b> Single top track aluminium, pre-drilled, screwed on Rail de roulement simple en alu, perforé, à visser	2500 mm 3500 mm 6000 mm	053.3117.250 053.3117.350 053.3117.600
<b>D Einfachlaufschiene Alu eloxiert, gelocht, zum Aufschauben</b> Single top track aluminium anodized, pre-drilled, surface mounted Rail de roulement simple en alu anodisé, perforé, à visser en applique	2500 mm 3500 mm 6000 mm	053.3069.250 053.3069.350 053.3069.600
<b>Clip-Blende zu Klemmschuh, Alu eloxiert</b> Clip panel for clamping shoe, aluminium anodized Cache à clipser pour mâchoire de serrage, en alu anodisé	2500 mm 3500 mm 6000 mm	053.3168.250 053.3168.350 053.3168.600

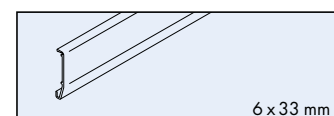
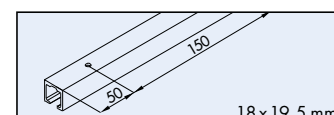
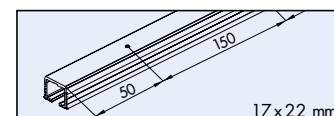
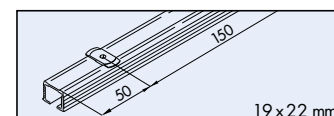
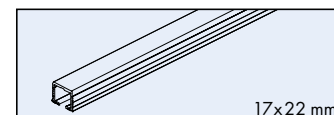

<b>Schienenendstück zu Einfachlaufschiene eingenetet, Kunststoff grau</b> Track-end piece for single top track groove mounted, plastic grey Pièce d'extrémité pour rail de roulement simple, rainuré, plastique gris	2 x 100 x	053.3062.003 053.3062.002
--	--------------	------------------------------

